

Other Ladder Tray

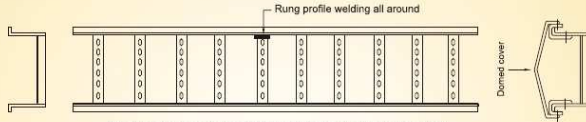

*Specially developed for food industry minimum deposit collects on tray.

Design Regd. No. 178612

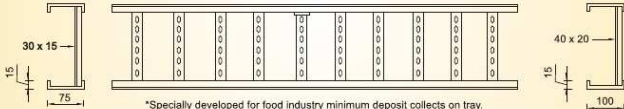

*Specially developed for food industry minimum deposit collects on tray.



*UNIQUE CONCEPT-Rung passes through side rail, welded externally, No grinding after rung welding. Improved galvanised quality results

Mounting & Clamping Products

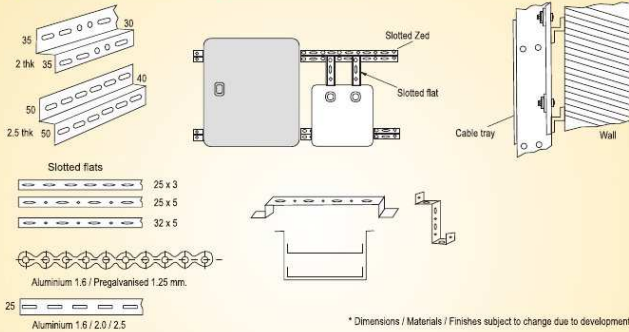

*Dimensions / Materials / Finishes subject to change due to development



MAX Cable Trays

7/174, Vellanaipatti Post, Kalapatti Via,
Coimbatore - 641048, India
Tel: 0422 2910980, Fax: 0422 2592795, Mobile: +91 9444082839
Email: muthu@maxcabletrays.com



Cable Management Systems



- Cable Tray : Perforated / Ladder
- Prefabricated Cable Tray Support System
- Cable Clamping Products

Flexi Rack

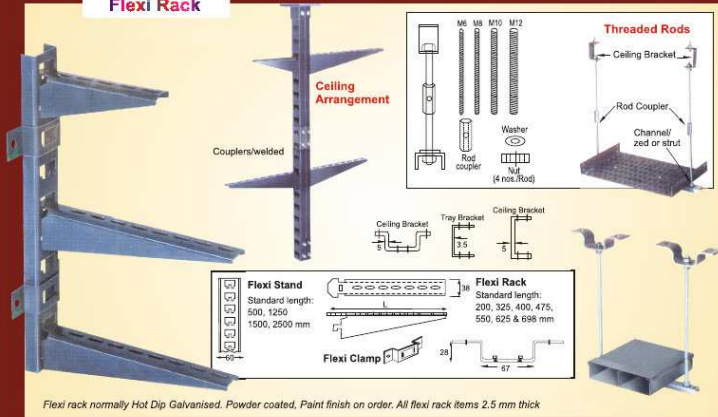

Boiltable Rack & Channel

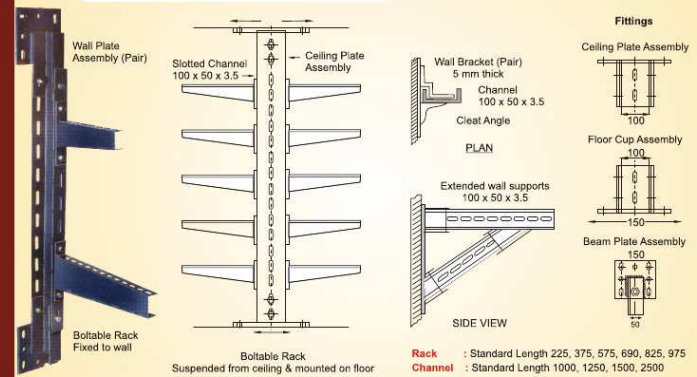

'C' strut metal framing system

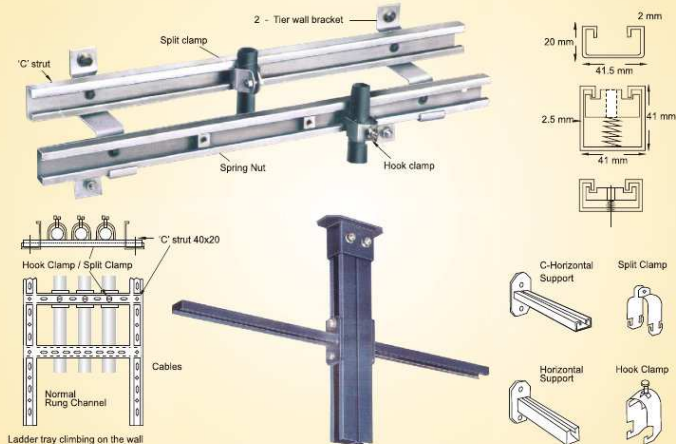

Rolled Angle with Slots / Holes

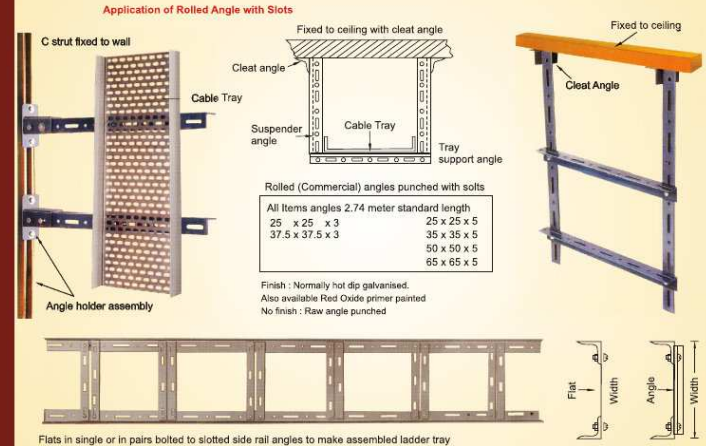

Perforated Standard Cable Tray

50 - 300 mm wide
transverse punch
pattern 20 x 10 mm

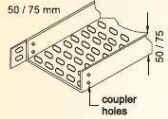
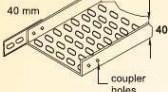
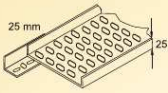

450 mm to 750 mm wide
Longitudinal punch pattern

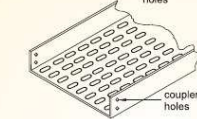
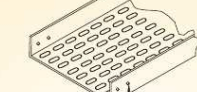
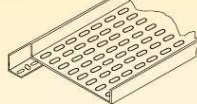

Material Thickness

1.6 mm M.S.
2.0 mm M.S./AL.
2.5 mm M.S./AL.
3.0 mm M.S./AL.

Couplers



2 nos per tray
2 fasteners M6 x 16
per coupler



2 nos per tray
2 fasteners M8 x 16
per coupler



2 nos per tray
2 fasteners M8 x 16
per coupler
(All fasteners zinc coated)

Material :

M.S. Hot rolled IS 1079, 1.6 mm - 3.0 mm.
Aluminium (Commercial grade), 1.6 mm - 3.0 mm.
CRCA Steel IS 513, 1.6 mm - 2.0 mm.
Pregalvanized M.S. IS 277, 1.6 mm - 2.0 mm.

*Against special Orders : 100 mm flange depth & reverse inward folds.

*100 mm depth with reverse inward flange folds

Covers :



Finish: Hot Dip Galvanised / Epoxy / Powercoated.
Finish: Self finish / Epoxy / Powercoated.

Finish: Epoxy / Powercoated only.

Finish: Hot Dip Galvanised / Epoxy / Powercoated.

Covers :

50 - 200 mm wide - 1pc / tray
300 - 750 mm wide - 2pcs / tray.

Material : Covers

Pregalvanized m.s.1.25 mm thk - 50 - 200 mm.

Pregalvanized m.s.1.6 mm thk - 300 - 750 mm.

Hot Dip Galvanised on m.s.1.6 mm thk (optional).

*Distortion corrected manually on hot galvanised covers.

Standard Bends :

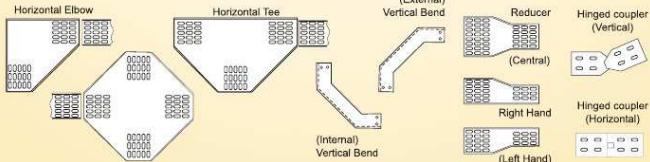

Bolted Rung Ladder Tray

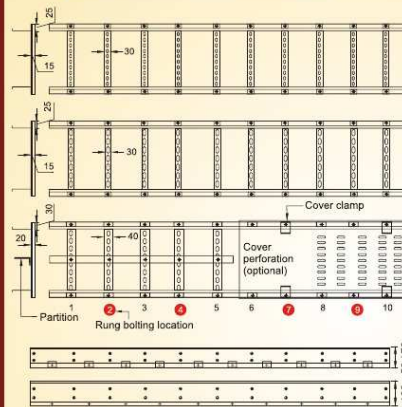

Material

Pregalvanized 2.0 thk
H.R mild steel 2.0 thk
Aluminium 2.0/2.5 thk

Finish

Nil
Hot galvanised
Ni (powder coating
optional)

Section Series

50
25
90
20
(5020)

Couplers

45
90
(2 nos per tray)

Pregalvanized 1.6 thk
CRCA steel 1.6 thk

Nil
Yellowzinc
plating/powder ctd.

50
25
90
20
(5016)

45
90
(2 nos per tray)

Pregalvanized
2.0/2.5 thk
H.R mild steel
2.0/2.5 thk
Aluminium 2.5 thk

Nil
Hot galvanised/
powder coated
Nil powder coated

70
30
90
20
(7020)

62
90
(2 nos per tray)

70
30
110
20
(10020)
(10025)

All above bolted ladder trays also available :-

a) Made of pregalvanized M.S. Sheet 2.0 mm (2.5 mtr std length)

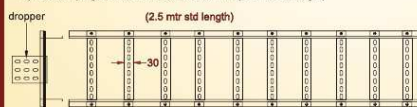

b) Made of Aluminium Sheet

2.0 mm (2.44 mtr std length) - 5020 / 7020 series

2.5 mm (2.44 mtr std length) - 7025 / 10025 series

Design Regd. No. 192504

Cover :

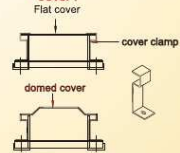

Standard Bends / Accessories

